



Z2300 Series User's Guide

Contents

Safety information.....	5
Introduction.....	6
Finding information about the printer.....	6
Setting up the printer.....	8
Bypassing security warnings during software installation.....	8
Understanding the parts of the printer.....	8
Understanding the parts of the printer.....	9
Installing printer software	9
Installing the optional XPS driver (Windows Vista users only)	10
Using the Windows printer software.....	11
Using the Macintosh printer software.....	12
Loading paper.....	13
Loading paper.....	13
Loading various paper types.....	13
Printing.....	16
Printing basic documents.....	16
Printing a document.....	16
Printing Web pages.....	16
Printing multiple copies of a document.....	17
Collating printed copies.....	17
Printing the last page first (reverse page order).....	18
Printing multiple pages on one sheet (N-Up).....	18
Canceling print jobs.....	19
Pausing print jobs.....	20
Printing specialty documents.....	21
Choosing compatible specialty paper types	21
Printing envelopes	21
Printing labels	22
Printing on custom-size paper.....	23
Printing other specialty documents	24
Saving and deleting print settings.....	24
Working with photos.....	26
Using recommended paper.....	26

Printing photos.....	26
Printing photos from a CD or removable storage device connected to the computer	26
Maintaining the printer.....	28
Maintaining print cartridges.....	28
Installing print cartridges.....	28
Removing a used print cartridge	29
Refilling print cartridges.....	30
Using genuine Lexmark print cartridges.....	30
Aligning the print cartridges	30
Cleaning the print cartridge nozzles.....	31
Wiping the print cartridge nozzles and contacts	31
Preserving the print cartridges	32
Cleaning the exterior of the printer.....	33
Ordering supplies.....	33
Ordering print cartridges	33
Ordering paper and other supplies.....	34
Troubleshooting.....	35
Using the printer troubleshooting software (Windows only).....	35
Setup troubleshooting.....	35
Power button is not lit	35
Software did not install.....	36
Page does not print.....	37
Removing and reinstalling the software	39
Enabling the USB port in Windows	40
Solving printer communication problems	41
Notices.....	42
Product information.....	42
Edition notice.....	42
European EC directives conformity statement for radio products.....	45
Power consumption.....	48
Index.....	53

Safety information

Use only the power supply and power supply cord provided with this product or the manufacturer's authorized replacement power supply and power supply cord.

Connect the power supply cord to an electrical outlet that is near the product and easily accessible.

 **CAUTION—POTENTIAL INJURY:** Do not twist, bind, crush, or place heavy objects on the power cord. Do not subject the power cord to abrasion or stress. Do not pinch the power cord between objects such as furniture and walls. If the power cord is misused, a risk of fire or electrical shock results. Inspect the power cord regularly for signs of misuse. Remove the power cord from the electrical outlet before inspecting it.

Refer service or repairs, other than those described in the user documentation, to a professional service person.

This product is designed, tested, and approved to meet strict global safety standards with the use of specific Lexmark components. The safety features of some parts may not always be obvious. Lexmark is not responsible for the use of other replacement parts.

 **CAUTION—SHOCK HAZARD:** Do not set up this product or make any electrical or cabling connections, such as the power supply cord or telephone, during a lightning storm.

SAVE THESE INSTRUCTIONS.

Introduction

Finding information about the printer

Publications

See the	For
<i>Quick Setup</i> sheet	Initial setup instructions that came with the printer.
Printed <i>Getting Started</i> guide	Additional setup instructions that came with the printer. Note: Not all products come with printed publications.
Electronic <i>User's Guide</i>	Complete instructions for using the printer. The electronic version installs automatically with the printer software.

Customer support

Description	Where to find (North America)	Where to find (rest of world)
Telephone support	<p>Call us at</p> <ul style="list-style-type: none">• US: 1-800-332-4120<ul style="list-style-type: none">– Monday–Friday (8:00 AM–11:00 PM EST), Saturday (Noon–6:00 PM EST)• Canada: 1-800-539-6275<ul style="list-style-type: none">– Support in English: Monday–Friday (8:00 AM–11:00 PM EST), Saturday (Noon–6:00 PM EST)– Support in French: Monday–Friday (9:00 AM–7:00 PM EST)• Mexico: 01-800-253-9627<ul style="list-style-type: none">– Monday–Friday (8:00 AM–8:00 PM EST) <p>Note: Support numbers and times may change without notice. For the most recent telephone numbers available, see the printed warranty statement that came with your printer.</p>	<p>Telephone numbers and support hours vary by country or region.</p> <p>Visit our Web site at www.lexmark.com. Select a country or region, and then select the Customer Support link.</p> <p>Note: For additional information about contacting Lexmark, see the printed warranty that came with your printer.</p>

Description	Where to find (North America)	Where to find (rest of world)
E-mail support	<p>For e-mail support, visit our Web site: www.lexmark.com.</p> <ol style="list-style-type: none"> 1 Click CUSTOMER SUPPORT. 2 Click Technical Support. 3 Select your printer family. 4 Select your printer model. 5 From the Support Tools section, click e-Mail Support. 6 Complete the form, and then click Submit Request. 	<p>E-mail support varies by country or region, and may not be available in some instances.</p> <p>Visit our Web site at www.lexmark.com. Select a country or region, and then select the Customer Support link.</p> <p>Note: For additional information about contacting Lexmark, see the printed warranty that came with your printer.</p>

Limited Warranty

Description	Where to find (USA)	Where to find (rest of world)
<p>Limited Warranty Information</p> <p>Lexmark International, Inc. furnishes a limited warranty that this printer will be free of defects in materials and workmanship for a period of 12 months after the original date of purchase.</p>	<p>To view the limitations and conditions of this limited warranty, see the Statement of Limited Warranty included with this printer, or set forth at www.lexmark.com.</p> <ol style="list-style-type: none"> 1 Click CUSTOMER SUPPORT. 2 Click Warranty Information. 3 From the Statement of Limited Warranty section, click Inkjet & All-In-One Printers. 4 Scroll through the Web page to view the warranty. 	<p>Warranty information varies by country or region. See the printed warranty that came with your printer.</p>

Record the following information (located on the store receipt and the back of the printer), and have it ready when you contact customer support so that they may serve you faster:

- Machine Type number
- Serial number
- Date purchased
- Store where purchased



Setting up the printer

Bypassing security warnings during software installation

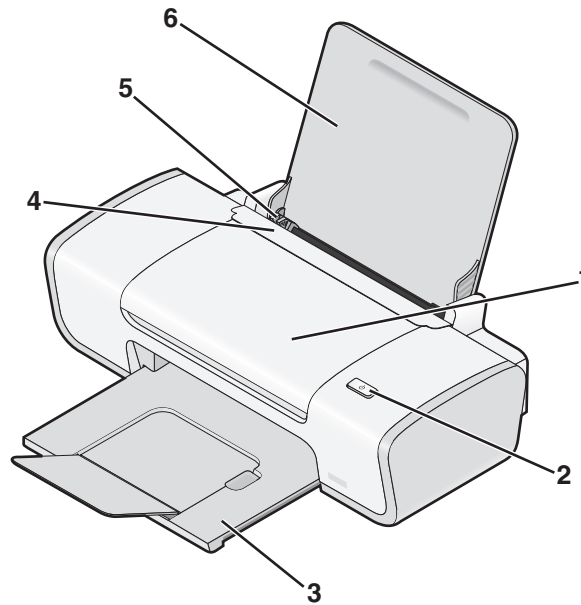

Third-party applications, including antivirus, security, and firewall programs may alert you about the printer software being installed. For your printer to work properly, allow the printer software to be installed on your computer.

Understanding the parts of the printer

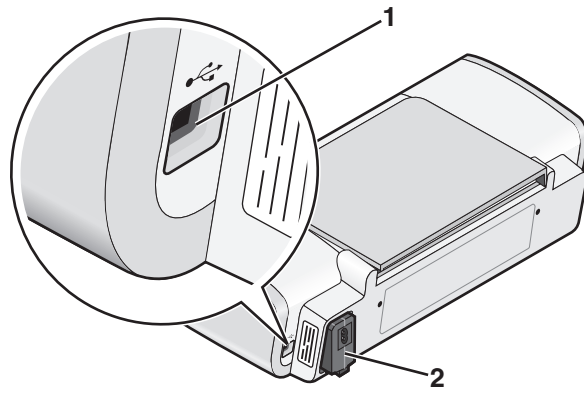

	Use the	To
1	Access cover	<ul style="list-style-type: none">• Install or change the print cartridges.• Clear paper jams.
2		<ul style="list-style-type: none">• Turn the printer on and off.• Cancel a print job. Press  in the middle of a print job.• Load or eject paper.
3	Paper exit tray	Stack paper as it exits.
4	Paper feed guard	Prevent items from falling into the paper slot.
5	Paper guide	Keep paper straight when feeding.
6	Paper support	Load paper.

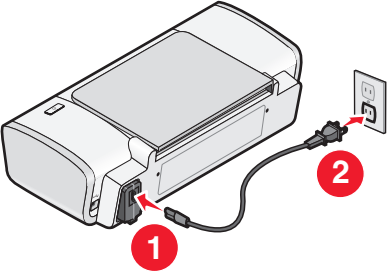

	Use the	To
1	USB port	Connect the printer to a computer using a USB cable. Warning—Potential Damage: Do not touch the USB port except when plugging in or removing a USB cable or installation cable.
2	Power supply	Connect the printer to a power source using the power cord. 1 Plug the power cord all the way into the power supply on the printer. 2 Plug the power cord into an electrical outlet that other electrical devices have been using.  3 If the  light is not on, press  .

Understanding the parts of the printer

Installing printer software

Using Windows

- 1 Close all open software programs.
- 2 Insert the printer software CD.
- 3 From the main installation screen, click **Install**.
- 4 Follow the instructions on the screens.

Using Macintosh

- 1 Close all open software applications.
- 2 Insert the printer software CD.
- 3 From the Finder desktop, double-click the printer CD icon that automatically appears.
- 4 Double-click the **Install** icon.
- 5 Follow the instructions on the screens.

Using the World Wide Web

- 1 Go to the Lexmark Web site at **www.lexmark.com**.
- 2 From the home page, navigate through the menu selection, and then click **Drivers & Downloads**.
- 3 Choose the printer and the printer driver for your operating system.
- 4 Follow the instructions on the screens to download the driver and install the printer software.

Installing the optional XPS driver (Windows Vista users only)

The XML Paper Specification (XPS) driver is an optional printer driver designed to make use of the advanced XPS color and graphics features that are available only for Windows Vista users. To use XPS features, you must install the XPS driver as an additional driver after you install the regular printer software.

Notes:

- Before installing the XPS driver, you must install the printer on your computer.
- Before installing the XPS driver, you must install the Microsoft QFE Patch and then extract the driver files from the installation software CD. To install the patch, you must have administrator privileges on the computer.

To install the Microsoft QFE Patch and extract the driver:

- 1 Insert the installation software CD, and then click **Cancel** when the Setup Wizard appears.
- 2 Click  → **Computer**.
- 3 Double-click the CD or DVD drive icon, and then double-click **Drivers**.
- 4 Double-click **xps**, and then double-click the **setupxps** file.

XPS driver files are copied to your computer, and any required Microsoft XPS files are launched. Follow the instructions on the screen to finish installing the patch.

To install the XPS driver:

- 1 Click  → **Control Panel**.
- 2 Under Hardware and Sound, click **Printer**, and then click **Add a Printer**.
- 3 From the Add Printer dialog, click **Add a local printer**.
- 4 From the "Use an existing port" drop-down menu, select **Virtual printer port for USB**, and then click **Next**.
- 5 Click **Have disk**.

The Install From Disk dialog appears.

6 Click **Browse**, and then navigate to the XPS driver files on your computer:

- a** Click **Computer**, and then double-click **(C:)**.
- b** Double-click **Drivers**, and then double-click **Printer**.
- c** Double-click the folder that has your printer model number, and then double-click **Drivers**.
- d** Double-click **xps**, and then click **Open**.
- e** From the **Install From Disk** dialog, click **OK**.

7 Click **Next** on the two additional dialogs that appear.

For more information on the XPS driver, see the XPS **readme** file on the installation software CD. The file is located in the xps folder with the setupxps batch file (D:\Drivers\xps\readme).

Using the Windows printer software

When you set up the printer using the printer software CD, all the necessary software was installed. You may have chosen to install some additional programs. The following table provides an overview of various software programs and what they can help you do.

Note: Not all of these programs are available on all printers. For example, if you purchased a printer that does not scan or fax items, then the printer software will not support these functions.

Use the	To
Lexmark™ Productivity Studio or Lexmark FastPics	<ul style="list-style-type: none">• Scan, copy, fax, e-mail, or print a photo or document.• Transfer photos.• Make photo greeting cards.• Adjust settings for the printer.
Lexmark Fax Solutions Software	<ul style="list-style-type: none">• Send a fax.• Receive a fax• Add, edit, or delete contacts in the built-in phone book.• Access the Lexmark Fax Setup Utility. Use the Lexmark Fax Setup Utility to set the Speed Dial and Group Dial numbers, set Ringing and Answering, and print fax history and status reports.
Printing Preferences	<p>When you select File → Print with a document open, a Printing Preferences dialog appears. The dialog lets you select options for the print job such as the following:</p> <ul style="list-style-type: none">• Select the number of copies to be printed.• Print two-sided copies.• Select the paper type.• Add a watermark.• Enhance images.• Save settings.
Lexmark Wireless Setup Utility	<ul style="list-style-type: none">• Set up the wireless printer on a wireless network.• Change the wireless settings of the printer.

Using the Macintosh printer software

Use the	To
Print dialog	Adjust the print settings and schedule print jobs.
Printer Services dialog	<ul style="list-style-type: none"> • Access the printer utility. • Troubleshoot. • Order ink or supplies. • Contact Lexmark. • Check the printer software version installed on the computer.

Applications are also installed with the printer software during installation. These applications are saved in the printer folder that appears on the Finder desktop after installation.

- 1 From the Finder desktop, double-click the printer folder.
- 2 Double-click the icon of the application that you want to use.

Use the	To
Lexmark All-In-One Center	<ul style="list-style-type: none"> • Scan photos and documents. • Customize settings for scan jobs.
Lexmark Fax Setup Utility	<ul style="list-style-type: none"> • Customize settings for fax jobs. • Create and edit the Speed Dial list.
Lexmark Network Card Reader	<ul style="list-style-type: none"> • View the contents of a memory device inserted into a network printer. • Transfer photos and documents from a memory device to the computer over a network.
Lexmark Printer Utility	<ul style="list-style-type: none"> • Get help with cartridge installation. • Print a test page. • Print an alignment page. • Clean the print cartridge nozzles. • Order ink or supplies. • Register the printer. • Contact customer support.
Lexmark Wireless Setup Assistant	Set up the printer on a wireless network.

Note: Your printer may not come with these applications, depending on the features of the printer that you purchased.

Loading paper

Loading paper

- 1 Make sure:
 - You use paper designed for inkjet printers.
 - The paper is not used or damaged.
 - If you are using specialty paper, you follow the instructions that came with it.
 - You do not force paper into the printer.
- 2 Load the paper vertically against the right side of the paper support.
- 3 Adjust the paper guide until it rests against the left edge of the paper.

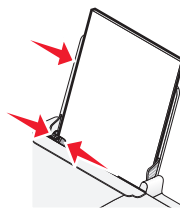

Note: To avoid paper jams, make sure the paper does not buckle when you adjust the paper guide.

Loading various paper types

Plain paper

Load up to 100 sheets of plain paper (depending on the thickness).

Make sure:

- The paper is designed for use with inkjet printers.
- The paper is loaded against the right side of the paper support.
- The paper guide rests against the left edge of the paper.
- The total thickness of paper does not exceed 10 mm (0.4 inches).

Glossy and photo paper

Load up to 25 sheets of glossy or photo paper.

Make sure:

- The glossy or printable side of the paper faces you. (If you are not sure which side is the printable side, see the instructions that came with the paper.)
- The paper is loaded against the right side of the paper support.
- The paper guide rests against the left edge of the paper.

Note: Photos require more drying time. Remove each photo as it exits, and allow it to dry to avoid ink smudging.

Iron-on transfers

Load up to 10 iron-on transfers.

Make sure:

- You follow the loading instructions that came with the iron-on transfers.
- The print side of the transfers faces you.
- The transfers are loaded against the right side of the paper support.
- The paper guide rests against the left edge of the transfers.

Note: For best results, load transfers one at a time.

Cards

Load up to 25 greeting cards, index cards, photo cards, or postcards.

Make sure:

- The total thickness of the card stack does not exceed 10 mm (0.4 inches).
- The print side of the cards faces you.
- The cards are loaded against the right side of the paper support.
- The paper guide rests against the left edge of the cards.

Envelopes

Load up to 10 envelopes.

Make sure:

- The stamp location is in the upper left corner.
- The print side of the envelopes faces you.
- The envelopes are loaded against the right side of the paper support.
- The paper guide rests against the left edge of the envelopes.

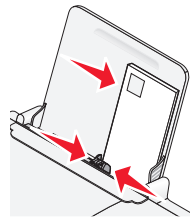

Warning—Potential Damage: Do not use envelopes that have metal clasps, string ties, or metal folding bars.

Notes:

- Do not load envelopes with holes, perforations, cutouts, or deep embossing.
- Do not use envelopes that have exposed flap adhesive.

Labels

Load up to 25 sheets of labels.

Make sure:

- You follow the loading instructions that came with the labels.
- The print side of the labels faces you.
- The adhesive on the labels does not extend to within 1 mm of the edge of the label.
- You use full label sheets. Partial sheets (with areas exposed by missing labels) may cause labels to peel off during printing, resulting in a paper jam.
- The labels are loaded against the right side of the paper support.
- The paper guide rests against the left edge of the labels.

Transparencies

Load up to 10 transparencies.

Make sure:

- The rough side of the transparencies faces you.
- You don't use transparencies with paper backing sheets.
- The transparencies are loaded against the right side of the paper support.
- The paper guide rests against the left edge of the transparencies.

Note: Transparencies require more drying time. Remove each transparency as it exits, and allow it to dry to avoid ink smudging.

Custom-size paper

Load up to 100 sheets of custom-size paper (depending on the thickness).

Make sure:

- The total thickness of paper does not exceed 10 mm (0.4 inches).
- The print side of the paper faces you.
- The paper size fits within these dimensions:

Width:

- 76–216 mm
- 3.0–8.5 inches

Length:

- 127–432 mm
- 5.0–17.0 inches

- The paper is loaded against the right side of the paper support.
- The paper guide rests against the left edge of the paper.

Printing

Printing basic documents

Printing a document

- 1 Load the paper.

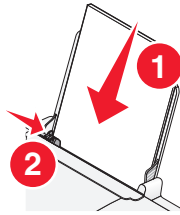

- 2 Do one of the following to print:

Using Windows

- a With a document open in a Windows program , click **File → Print**.
- b Click **Properties, Preferences, Options, or Setup**.
- c Select the print quality, the number of copies to print, the type of paper to be used, and how the pages should print.
- d Click **OK** to close any printer software dialogs.
- e Click **OK** or **Print**.

Using Macintosh

- a With a document open in a Macintosh application, click **File → Print**.
- b From the Printer pop-up menu, choose the printer.
- c From the print options pop-up menu, choose the print quality, the number of copies to print, the type of paper to be used, and how the pages should print.
- d Click **Print**.

Printing Web pages

If you chose to install the Lexmark Toolbar software for your Web browser, then you can use it to create a printer-friendly version of any Web page.

Notes:

- For Windows, the software supports Microsoft Internet Explorer 5.5 or later or a compatible version of Firefox.
- For Macintosh, the software supports a compatible version of Firefox.



- 1 Load paper.
- 2 Open a Web page using a supported browser.
- 3 Select a print option to print the page.
You can also adjust settings or preview the page before printing.

Printing multiple copies of a document

Using Windows

- 1 With a document open, click **File → Print**.
- 2 Click **Properties, Preferences, Options, or Setup**.
- 3 From the Copies section of the Print Setup tab, enter the number of copies that you want to print.
- 4 Click **OK** to close any printer software dialogs.
- 5 Click **OK** or **Print**.

Using Macintosh

- 1 With a document open, click **File → Print**.
- 2 From the Printer pop-up menu, choose the printer.
- 3 In the Copies field, enter the number of copies that you want to print.
- 4 Click **Print**.

Collating printed copies

If you print multiple copies of a document, you can choose to print each copy as a set (collated) or to print the copies as groups of pages (not collated).

Collated



Not collated

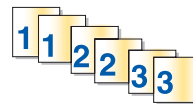

Using Windows

- 1 With a document open, click **File → Print**.
- 2 Click **Properties, Preferences, Options, or Setup**.
- 3 From the Copies section of the Print Setup tab, enter the number of copies that you want to print, and then select **Collate Copies**.
- 4 Click **OK** to close any printer software dialogs.
- 5 Click **OK** or **Print**.

Note: The collate option is available only when you are printing multiple copies.

Using Macintosh

- 1 With a document open, click **File → Print**.
- 2 In the Copies field, enter the number of copies that you want to print, and then select **Collated**.
- 3 Click **Print**.

Note: To prevent smudging when printing photos, remove each photo as it exits the printer, and then let it dry before stacking.

Printing the last page first (reverse page order)

Using Windows

- 1 With a document open, click **File → Print**.
- 2 Click **Properties, Preferences, Options, or Setup**.
- 3 From the Copies section of the Print Setup tab, select **Print Last Page First**.
- 4 Click **OK** to close any printer software dialogs.
- 5 Click **OK** or **Print**.

Using Macintosh

- 1 With a document open, click **File → Print**.
- 2 From the Printer pop-up menu, choose the printer.
- 3 Do one of the following:

For Mac OS X version 10.5

- a From the print options pop-up menu, choose **Layout**.
- b Select **Reverse Page Orientation**.

For Mac OS X version 10.4

- a From the print options pop-up menu, choose **Paper Handling**.
- b From the Page Order menu, select **Reverse**.

For Mac OS X version 10.3

- a From the print options pop-up menu, choose **Paper Handling**.
- b Select **Reverse page order**.

- 4 Click **Print**.

Printing multiple pages on one sheet (N-Up)

Using Windows

- 1 With a document open, click **File → Print**.
- 2 Click **Properties, Preferences, Options, or Setup**.

- 3** From the **Advanced** tab, select **N-Up** under the Layout drop-down menu.
- 4** Select the number of page images to print on each page.
If you want each page image to be surrounded by a border, then select **Print Page Borders**.
- 5** Click **OK** to close any printer software dialogs.
- 6** Click **OK** or **Print**.

Using Macintosh

- 1** With a document open, click **File → Print**.
- 2** From the print options pop-up menu, choose **Layout**.
 - From the Pages per Sheet pop-up menu, choose the number of page images that you want to print on one sheet.
 - From the Layout Direction area, click the icon that shows the order that you want the page images to print on one sheet.
 - If you want to print a border around each page image, then choose an option from the Border pop-up menu.
- 3** Click **Print**.

Canceling print jobs

Using the printer control panel

Press **X**.

Using the printing status window of the printer

The printing status window automatically opens at the bottom-right part of your screen when you send a print job. Click **Cancel Printing** to cancel the print job.

Using the printer folder in Windows

- 1** Do one of the following:

In Windows Vista

- a** Click .
- b** Click **Control Panel**.
- c** Under Hardware and Sound, click **Printer**.

In Windows XP

- a** Click **Start**.
- b** Click **Printers and Faxes**.

In Windows 2000

- a** Click **Start**.
- b** Click **Settings → Printers**.

- 2** Right-click the printer name, and then select **Open**.

3 Do one of the following:

- If you want to cancel a particular print job, right-click the document name, and then select **Cancel**.
- If you want to cancel all print jobs in the queue, click **Printer → Cancel All Documents**.

Using the taskbar in Windows

1 Double-click the printer icon in the taskbar.

2 Do one of the following:

- If you want to cancel a particular print job, right-click the document name, and then select **Cancel**.
- If you want to cancel all print jobs in the queue, click **Printer → Cancel All Documents**.

Using Macintosh

1 While the document is printing, click the printer icon in the Dock.

2 From the print queue dialog, choose the job that you want to cancel, and then click **Delete**.

Pausing print jobs

Using the printer folder in Windows

1 Do one of the following:

In Windows Vista

- a Click .
- b Click **Control Panel**.
- c Under **Hardware and Sound**, click **Printer**.

In Windows XP

- a Click **Start**.
- b Click **Printers and Faxes**.

In Windows 2000

- a Click **Start**.
- b Click **Settings → Printers**.

2 Right-click the printer, and then select **Pause Printing**.

Using the taskbar in Windows

1 Double-click the printer icon in the taskbar.

2 Right-click the document name, and then select **Pause**.

Using Macintosh

- 1 While the document is printing, click the printer icon in the Dock.
The print queue dialog appears.
- 2 Do one of the following:
 - If you want to pause a particular print job, choose the document name, and then click **Hold**.
 - If you want to pause all print jobs in the queue, click **Pause Printer** or **Stop Jobs**, depending on the operating system version that you are using.

Printing specialty documents

Choosing compatible specialty paper types

- **Heavyweight matte paper**—A photo paper with a matte finish used for printing high-quality graphics.
- **Photo/Glossy paper**—Photo paper with a special coating. It is used specifically for printing photos with crisp, sharp images.
- **Lexmark Photo Paper**—An outstanding "everyday" heavyweight inkjet photo paper designed for use with Lexmark printers, but compatible with all brands of inkjet printers. Although inexpensive, it offers excellent image quality and outstanding value.
- **Lexmark Premium Photo Paper**—A high-gloss, heavyweight quality photo paper specifically designed to work with Lexmark's evercolor™ inks for eye-catching, color-rich results. It is great for those special photos to be framed, placed in an album, or shared with friends and family.
- **Lexmark PerfectFinish™ Photo Paper**—A high-quality photo paper specifically designed for Lexmark inkjet printers, but compatible with all inkjet printers. It is used specifically for printing professional quality photos with a glossy finish. It is best when used with genuine Lexmark evercolor 2 ink, providing photos that are fade- and water-resistant.
- **Transparency**—A clear, plastic media primarily used for overhead projectors.
- **Card stock**—A very thick paper used for printing sturdier items, such as greeting cards.
- **Iron-On transfer**—A type of media that has a reverse image printed on it that can be ironed onto fabric.

Printing envelopes

- 1 Load the envelopes in the printer.

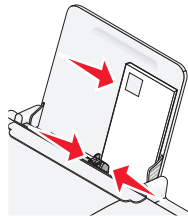

- 2 Do one of the following:

Using Windows

- a With a document open, click **File → Print**.
- b Click **Properties, Preferences, Options, or Setup**.
- c From the Media Type list of the Print Setup tab, select **Plain**.

d From the Paper Size list, select the envelope size.

Note: To print on a custom-size envelope, select **Custom Size**, and then specify the height and width of the envelope.

e Select **Portrait** or **Landscape** orientation.

f Click **OK** to close any printer software dialogs.

g Click **OK** or **Print**.

Using Macintosh

a Customize the settings as needed in the Page Setup dialog.

1 With a document open, click **File → Page Setup**.

2 From the “Format for” pop-up menu, choose the envelope size. If no size matches the size of the envelope, then set a custom size.

3 Select an orientation.

4 Click **OK**.

b Customize the settings as needed in the Print dialog.

1 With a document open, click **File → Print**.

2 From the Printer pop-up menu, choose the printer that you want to use.

3 Click **Print**.

Notes:

- Most envelopes use landscape orientation.
- Make sure the same orientation is also selected in the software application.

Printing labels

1 Load the label sheets in the printer.

2 Do one of the following:

Using Windows

a With a document open, click **File → Print**.

b Click **Properties**, **Preferences**, **Options**, or **Setup**.

c From the Paper Size drop-down menu of the Print Setup tab, choose a paper size that matches the size of the label sheet. If no paper size matches the label sheet size, then set a custom size.

If necessary, choose the appropriate type of media from the Media Type drop-down menu.

d Click **OK** to close any printer software dialogs.

e Click **OK** or **Print**.

Using Macintosh

a Customize the settings as needed in the Page Setup dialog.

1 With a document open, choose **File → Page Setup**.

2 From the “Format for” pop-up menu, choose the printer that you want to use.

3 From the Paper Size pop-up menu, choose a paper size that matches the size of the label sheet. If no paper size matches the label sheet size, then create a custom size.

- b** Customize the settings as needed in the Print dialog.
 - 1** With a document open, click **File → Print**.
 - 2** From the Printer pop-up menu, choose the printer that you want to use.
 - 3** From the print options pop-up menu, choose **Quality & Media**.
 - 4** From the Paper type pop-up menu, choose a paper type.
 - 5** From the Print Quality menu, choose a print quality other than Quick Print.

Tips on loading label sheets

- Make sure the top of the label sheet feeds into the printer first.
- Make sure the adhesive on the labels does not extend to within 1 mm of the edge of the label sheet.
- Make sure the paper guide or paper guides rest against the edges of the label sheet.
- Use full label sheets. Partial sheets (with areas exposed by missing labels) may cause labels to peel off during printing, resulting in a paper jam.

Note: Labels require more drying time. Remove each label sheet as it exits, and then allow it to dry to avoid ink smudging.

Printing on custom-size paper

Before beginning these instructions, load the custom-size paper in the printer. For more information, see the “Loading Paper” chapter.

Using Windows

- 1** With a document open, click **File → Print**.
- 2** Click **Properties, Preferences, Options, or Setup**.
The Print Setup tab appears.
- 3** In the Paper Options section, from the “Paper size” list, select **Custom Size**.
The Define Custom Paper Size dialog appears.
- 4** Select the measurement units to use (inches or millimeters).
- 5** Click **OK** to close any printer software dialogs that are open.
- 6** Print the document.

Using Macintosh

- 1** With a document open, click **File → Page Setup**.
- 2** From the Paper size pop-up menu, choose **Manage Custom Sizes**.
- 3** Create a custom size.
 - a** Click **+**.
 - b** In the Page Size menu, type the Width and Height of the paper.
 - c** From the Printer Margins pop-up menu, choose the printer that you want to use. The margins are set by the printer.
If you want to set the margins, choose **User defined**, and then type the margins in the Printer Margins area.

- d From the custom sizes list on the left of the dialog, double-click **Untitled**, and then type a name for the custom paper size you set.
 - e Click **OK**.
- 4 Open the Paper size pop-up menu again, and then choose the name of the custom paper size you added in Step 3d.
 - 5 Click **Print**.

Printing other specialty documents

When you installed the printer driver, some printer software was installed that may help you print specialty documents such as booklets, posters, iron-on transfers, transparencies, and banners. For information about printing these documents, see the Help installed with the programs or applications you choose to use.

Using Windows

- 1 Do one of the following:
 - In Windows Vista, click  → **All Programs**, and then select the printer program folder from the list.
 - In Windows XP, click **Start** → **Programs** or **All Programs**, and then select the printer program folder from the list.
- 2 Click the program that you want to use.

Using Macintosh

- 1 From the Finder desktop, double-click the printer folder.
If the printer folder is not found on the desktop:
 - a Go to the Mac OS X drive where the printer software was installed.
 - b Choose **Library** → **Printers** → **YYYY** → **Lexmark**, and then select your printer model.
YYYY is the year that the printer was released.
- 2 Double-click the application that you want to use.

Saving and deleting print settings

Using Windows

- 1 With a document open, click **File** → **Print**.
- 2 Click **Properties**, **Preferences**, **Options**, or **Setup**.
- 3 Make adjustments to the settings.
- 4 Click **Profiles**, and then click **Save your current settings**.
- 5 Select an empty location for your setting, and then assign a name.
Note: The first location contains Factory Default Settings, which cannot be changed or deleted.
- 6 Click **Save**.
- 7 Close all open software dialogs.

Notes:

- To retrieve your print settings, click **Profiles → Restore a Profile**, and then select the name of the profile that you want to use.
- To delete a setting, click **Profiles → Delete Profiles**. Select the setting that you want to delete, and then click **Delete**.

Using Macintosh

The Presets pop-up menu lets you save the print settings you use often. When print settings are saved into a Preset, there is no need to adjust the print settings for every print job.

- 1** With a document open, click **File → Print**.
- 2** From the print options pop-up menu, choose and adjust the settings.
- 3** From the Presets pop-up menu, choose **Save As**.
The Save Preset dialog appears.
- 4** Type a name for the Preset.
- 5** Click **OK**.

Working with photos

Using recommended paper

For best results when printing photos or other high-quality images, use Lexmark Photo Paper or Lexmark PerfectFinish Photo Paper.

Printing photos

Printing photos from a CD or removable storage device connected to the computer

Using Windows

- 1 Load photo paper with the glossy or printable side facing you. (If you are not sure which side is the printable side, see the instructions that came with the paper.)
- 2 Insert a CD or any removable storage device (such as a flash drive, memory card, or digital camera) into the computer.
If you install Lexmark FastPics or Lexmark Productivity Studio, then the software will launch when you insert the flash drive, memory card, or digital camera.
- 3 Follow the instructions on the computer screen to print photos.
- 4 Remove the CD or storage device.

Using Macintosh

- 1 Load photo paper with the glossy or printable side facing you. (If you are not sure which side is the printable side, see the instructions that came with the paper.)
- 2 Insert a CD or any removable storage device (such as a flash drive, memory card, or digital camera) into the computer.
- 3 Customize the settings as needed in the Page Setup dialog.
 - a With a photo open, choose **File → Page Setup**.
 - b From the "Format for" pop-up menu, choose your printer series.
 - c From the Paper Size pop-up menu, choose the paper size loaded.
 - d Choose an orientation.
 - e Click **OK**.
- 4 Customize the settings as needed in the Print dialog.
 - a With a photo open, choose **File → Print**.
 - b From the "Format for" pop-up menu, choose your printer series.
 - c For Mac OS X version 10.4 or later, click **Advanced**. Otherwise, proceed to the next step.
 - d From the Copies & Pages pop-up menu, type the number of copies to be printed.

e From the same pop-up menu, choose **Quality & Media**.

- From the Paper Type pop-up menu, choose the type of paper you are using.
- From the Print Quality area, choose **Automatic** or **Photo**.

f Click **Print**.

5 Remove the CD or storage device.

Maintaining the printer

Maintaining print cartridges

Installing print cartridges

- 1 Open the access cover, and then press down on the cartridge carrier levers.

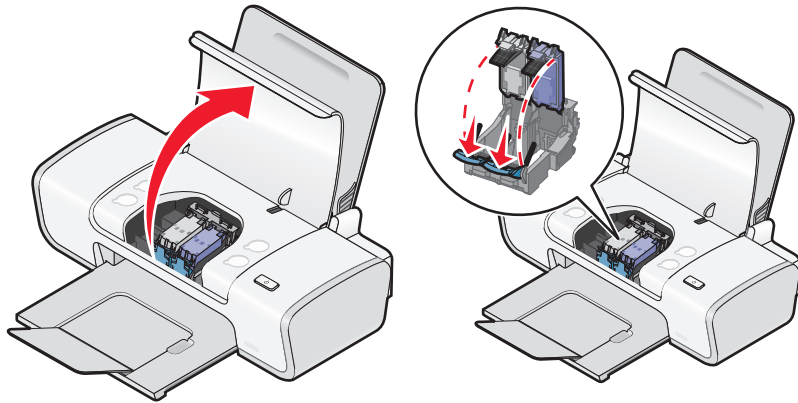

- 2 Remove the used print cartridge or cartridges.
- 3 If you are installing new print cartridges, remove the tape from the back and bottom of the black cartridge, insert the cartridge in the left carrier, and then close the black cartridge carrier lid.

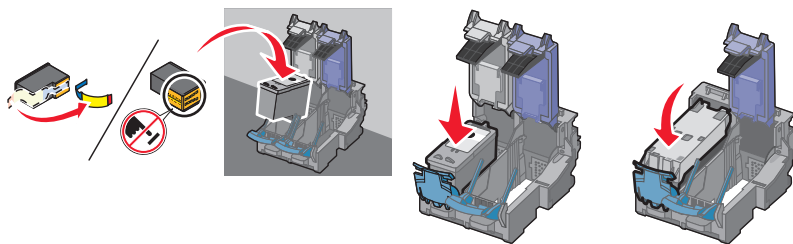

Warning—Potential Damage: Do *not* touch the gold contact area on the back or the metal nozzles on the bottom of the cartridge.

- 4 Remove the tape from the back and bottom of the color cartridge, insert the cartridge in the right carrier, and then close the color cartridge carrier lid.

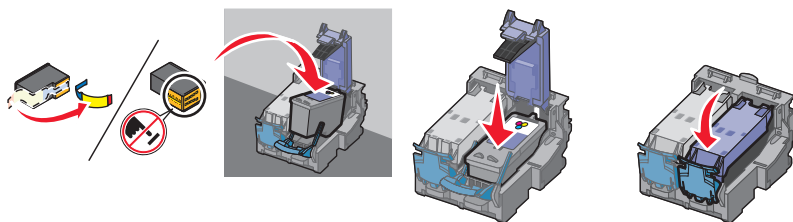

Warning—Potential Damage: Do *not* touch the gold contact area on the back or the metal nozzles on the bottom of the cartridge.

- 5 Close the access cover.

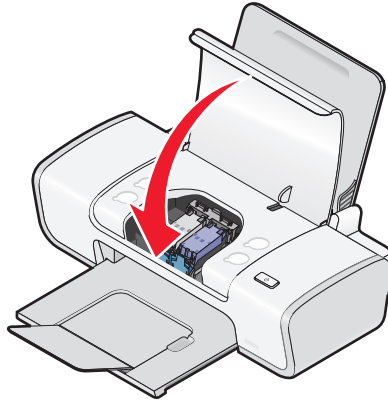

Note: The printer must be closed to start a new print job.

Removing a used print cartridge

- 1 Make sure the printer is on.
- 2 Lift the access cover.

The print cartridge carrier moves and stops at the loading position, unless the printer is busy.



- 3 Press down on the cartridge carrier lever to raise the cartridge carrier lid.

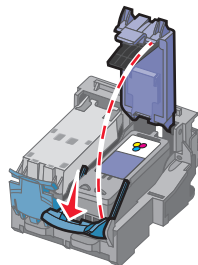

- 4 Remove the used print cartridge.

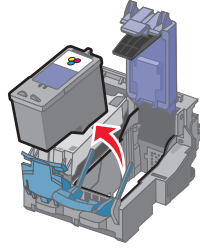

Refilling print cartridges

The warranty does not cover repair of failures or damage caused by a refilled cartridge. Lexmark does not recommend use of a refilled cartridge. Refilling a cartridge can affect print quality and may cause damage to the printer. For best results, use Lexmark supplies.

Using genuine Lexmark print cartridges

Lexmark printers, print cartridges, and photo paper are designed to perform together for superior print quality.

If you receive an **Out of Original Lexmark Ink** message, the original Lexmark ink in the indicated cartridge (s) has been depleted.

If you believe you purchased a new, genuine Lexmark print cartridge, but the **Out of Original Lexmark Ink** message appears:

- 1 Click **Learn More** on the message.
- 2 Click **Report a non-Lexmark print cartridge**.

To prevent the message from appearing again for the indicated cartridge(s):

- Replace your cartridge(s) with new Lexmark print cartridge(s).
- If you are printing from a computer, click **Learn more** on the message, select the check box, and then click **Close**.
- If you are using the printer without a computer, press **Cancel**.

Lexmark's warranty does not cover damage caused by non-Lexmark ink or print cartridges.

Aligning the print cartridges

Using Windows

- 1 Load plain paper.
- 2 Click **Start → Programs** or **All Programs**, and then click the printer folder.
- 3 From the printer folder, click **Maintenance → Align cartridges**.
- 4 Click **Print**.
- 5 Follow the instructions on the computer screen.
- 6 If you aligned the cartridges to improve print quality, print your document again. If print quality has not improved, clean the print cartridge nozzles.

Using Macintosh

- 1 Load plain paper.
- 2 From the Finder desktop, double-click the printer folder.
- 3 Double-click the printer utility icon.
- 4 From the Maintenance tab, click **Print Alignment Page**.
- 5 Follow the instructions on the computer screen.
- 6 If you aligned the cartridges to improve print quality, print your document again. If print quality has not improved, clean the print cartridge nozzles.

Cleaning the print cartridge nozzles

Using Windows

- 1 Load plain paper.
- 2 Click **Start → Programs** or **All Programs**, and then click the printer folder.
- 3 From the printer folder, click **Maintenance → Clean cartridges**.
- 4 Click **Print**.
- 5 Follow the instructions on the computer screen.
- 6 If print quality has not improved, then wipe the print cartridge nozzles and contacts.

Using Macintosh

- 1 Load plain paper.
- 2 From the Finder desktop, double click the printer folder.
- 3 Double-click the printer utility icon.
- 4 From the Maintenance tab, click **Clean Print Nozzles**.
A page prints, forcing ink through the print cartridge nozzles to clean them.
- 5 To test if the print quality has improved, print the document again.
- 6 If print quality has not improved, then try cleaning the nozzles up to two more times.

Wiping the print cartridge nozzles and contacts

- 1 Remove the print cartridge(s).
- 2 Dampen a clean, lint-free cloth with water, and then place the cloth on a flat surface.

3 Gently hold the nozzles against the cloth for about three seconds, and then wipe in the direction shown.

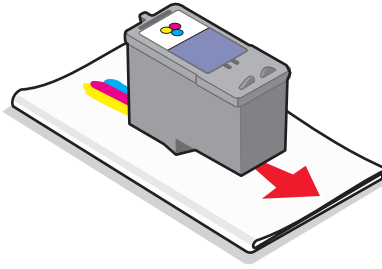

4 Using another clean section of the cloth, gently hold the cloth against the contacts for about three seconds, and then wipe in the direction shown.

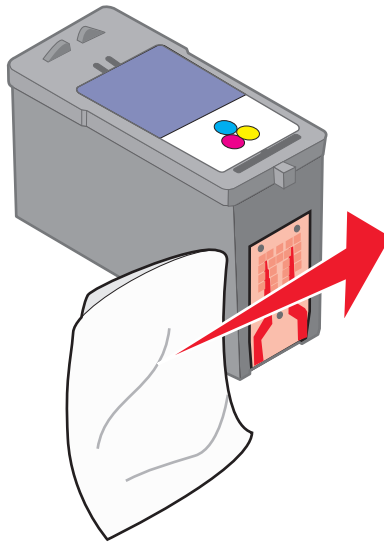

5 With another clean section of the cloth, repeat step 3 and step 4, and then let the nozzles and contacts dry completely.

6 Reinsert the print cartridge(s), and then print the document again.

7 If the print quality does not improve, clean the print nozzles, and then try printing the document again.

8 Repeat step 7 up to two more times.

9 If print quality is still not satisfactory, replace the print cartridge(s).

Preserving the print cartridges

- Keep new cartridges in their packaging until you are ready to install them.
- Do not remove a cartridge from the printer except to replace, clean, or store it in an airtight container. The cartridges do not print correctly if left exposed for an extended period of time.

Cleaning the exterior of the printer

1 Make sure that the printer is turned off and unplugged from the wall outlet.



CAUTION—SHOCK HAZARD: To avoid the risk of electric shock, unplug the power cord from the wall outlet and disconnect all cables to the printer before proceeding.

2 Remove paper from the paper support and paper exit tray.

3 Dampen a clean, lint-free cloth with water.

Warning—Potential Damage: Do not use household cleaners or detergents, as they may damage the finish of the printer.

4 Wipe only the outside of the printer, making sure to remove any ink residue that has accumulated on the paper exit tray.

Warning—Potential Damage: Using a damp cloth to clean the interior may cause damage to your printer.

5 Make sure the paper support and paper exit tray are dry before beginning a new print job.

Ordering supplies

Ordering print cartridges

Lexmark Z2300 Series models (except Lexmark Z2390)

Item	Part number	Average cartridge standard page yield ¹
Black cartridge	14A	For page yield values, refer to www.lexmark.com/pageyields .
Black cartridge ²	14	
Color cartridge	15A	
Color cartridge ²	15	
Photo cartridge	31	Not applicable
¹ Values obtained by continuous printing. Declared yield value in accordance with ISO/IEC 24711 ² Licensed Return Program Cartridge		

Lexmark Z2390 model

Item	Part number	Average cartridge standard page yield ¹
Black cartridge	4A	For page yield values, refer to www.lexmark.com/pageyields .
Black cartridge ²	4	
Color cartridge	5A	
Color cartridge ²	5	
Photo cartridge	31	Not applicable
¹ Values obtained by continuous printing. Declared yield value in accordance with ISO/IEC 24711 ² Licensed Return Program Cartridge		

Ordering paper and other supplies

To purchase supplies or to locate a dealer near you, visit our Web site at www.lexmark.com.

For best results when printing photos or other high-quality images, use Lexmark Photo Paper or Lexmark PerfectFinish Photo Paper and Lexmark print cartridges.

Item	Description
Lexmark Photo Paper	<ul style="list-style-type: none">• Letter• A4• 4 x 6 in.• 10 x 15 cm
Lexmark PerfectFinish Photo Paper	<ul style="list-style-type: none">• Letter• A4• 4 x 6 in.• 10 x 15 cm• L
USB cable	Part number 1021294

Troubleshooting

Using the printer troubleshooting software (Windows only)

The Lexmark Service Center provides step-by-step troubleshooting help and contains links to printer maintenance tasks and customer support.

To open the Lexmark Service Center, use one of these methods:

Method 1	Method 2
If it appears on an error message dialog, click the For additional assistance, use the Lexmark Service Center link.	<ol style="list-style-type: none">1 Do one of the following:<ul style="list-style-type: none">• In Windows Vista, click  → All Programs, and then select the printer program folder from the list.• In Windows XP, click Start → Programs or All Programs, and then select the printer program folder from the list.2 Select Lexmark Service Center.

Setup troubleshooting

Power button is not lit

These are possible solutions. Try one or more of the following:

PRESS POWER BUTTON

Make sure the printer is on by pressing .

DISCONNECT AND RECONNECT THE POWER CORD

- 1 Press  to turn the printer off.
- 2 Disconnect the power cord from the wall outlet.
- 3 Disconnect the power cord from the power supply.
- 4 Plug the power cord all the way into the power supply on the printer.

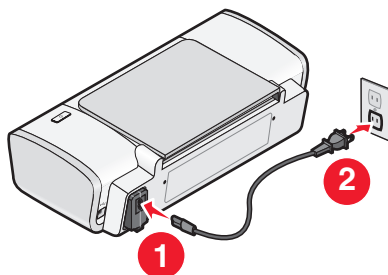

- 5 Plug the power cord into the wall outlet.
- 6 Press  to turn the printer on.

Software did not install

If you encountered problems while installing, or if your printer does not appear in the list in the Printers folder or as a printer option when sending a print job, you can try uninstalling and reinstalling the software.

These are some other possible solutions. Try one or more of the following:

MAKE SURE YOUR OPERATING SYSTEM IS SUPPORTED

The following operating systems are supported: Windows Vista, Windows XP, Windows 2000 with Service Pack 3 or later, and Mac OS X versions 10.5, 10.4 and 10.3.



CHECK THAT YOUR COMPUTER MEETS THE MINIMUM SYSTEM REQUIREMENTS LISTED ON THE PRINTER BOX

CHECK THE USB CONNECTION

- 1 Check the USB cable for any obvious damage. If the cable is damaged, use a new one.
- 2 Firmly plug the square end of the USB cable into the back of the printer.
- 3 Firmly plug the rectangular end of the USB cable into the USB port of the computer.

The USB port is marked with the  USB symbol.

RECONNECT THE POWER SUPPLY

- 1 Press  to turn the printer off.
- 2 Disconnect the power cord from the wall outlet.
- 3 Gently remove the power supply from the printer.
- 4 Reconnect the power supply to the printer.
- 5 Plug the power cord into the wall outlet.
- 6 Press  to turn the printer on.

TEMPORARILY DISABLE SECURITY PROGRAMS IN WINDOWS

- 1 Close all open programs.
- 2 Disable any security programs.
- 3 Do one of the following:
 - In Windows Vista, click .
 - In Windows XP and earlier, click **Start**.
- 4 Click **Computer** or **My Computer**.
- 5 Double-click the CD or DVD drive icon.

- 6 If necessary, double-click **setup.exe**.
- 7 Follow the instructions on the computer screen to install the software.
- 8 When the installation is completed, enable the security software again.

Page does not print

These are possible solutions. Try one or more of the following:

CHECK MESSAGES

If an error message appears, then resolve the error before trying to print again.

CHECK POWER

If the  light is not on, then make sure that the power cord is properly connected to the printer and plugged into a known working electrical outlet that other electrical devices have been using.

REMOVE AND THEN RELOAD PAPER

CHECK INK

Check the ink levels, and then install new print cartridges if necessary.

CHECK CARTRIDGES

- 1 Remove the print cartridges.
- 2 Make sure the sticker and tape have been removed.



- 3 Reinsert the cartridges.

CHECK PRINTER DEFAULT AND PAUSE SETTINGS

Using Windows

- 1 Do one of the following:

In Windows Vista

- a Click .
- b Click **Control Panel**.
- c Under Hardware and Sound, click **Printer**.

In Windows XP

- a Click **Start**.
- b Click **Printers and Faxes**.

In Windows 2000

- a** Click **Start**.
 - b** Click **Settings → Printers**.
- 2** Double-click the printer.
- 3** Click **Printer**.
 - Make sure no check mark appears next to Pause Printing.
 - If a check mark does not appear next to Set As Default Printer, then you must select the printer for each file that you want to print.

Using Macintosh



For Mac OS X version 10.5

- 1** From the Finder desktop, click  → **System Preferences → Print & Fax**.
- 2** From the Default Printer pop-up menu, check if the printer is the default printer.
If the printer is not the default printer, then you must select the printer for each file that you want to print.
If you want to set the printer as the default printer, then select the printer from the Default Printer pop-up menu.
- 3** Click **Open Print Queue**.
The print queue dialog appears.
Make sure that the print job is not on hold. If the print job is on hold:
 - If you want to resume a particular print job, choose the document name, and then click **Resume**.
 - If you want to resume all print jobs in the queue, then click **Resume Printer**.

For Mac OS X version 10.4 and earlier

- 1** From the Finder desktop, click **Go → Utilities → Print Center** or **Printer Setup Utility**.
The Printer List dialog appears.
- 2** Double-click the printer.
The print queue dialog appears.
 - Make sure that the print job is not on hold.
If the print job is on hold:
 - If you want to resume a particular print job, choose the document name, and then click **Resume**.
 - If you want to resume all print jobs in the queue, then click **Start Jobs**.
 - If the printer is not in bold, then it is not the default printer. You must select the printer for each file that you want to print.
If you want to set the printer as the default printer:
 - a** Go back to the Printer List dialog, and then select the printer.
 - b** Click **Make Default**.

DISCONNECT AND RECONNECT POWER SUPPLY

- 1 Press  to turn off the printer.
- 2 Disconnect the power cord from the wall outlet.
- 3 Remove the power supply from the printer.
- 4 Reconnect the power supply to the printer.
- 5 Plug the power cord into the wall outlet.
- 6 Press  to turn on the printer.

REMOVE AND REINSTALL THE SOFTWARE

If you encountered problems while installing, or if your printer does not appear in the printers folder or as a printer option when sending a print job, then try uninstalling and reinstalling the software.

Removing and reinstalling the software

If the printer is not functioning properly, or if a communications error message appears when you try to use the printer, you may need to remove and reinstall the printer software.

Using Windows

- 1 Do one of the following:
 - In Windows Vista, click .
 - In Windows XP, click **Start**.
- 2 Click **Programs** or **All Programs**, and then select the printer program folder from the list.
- 3 Select **Uninstall**.
- 4 Follow the instructions on the computer screen to remove the printer software.
- 5 Restart the computer before reinstalling the printer software.
- 6 Click **Cancel** on all New Hardware Found screens.
- 7 Insert the installation CD, and then follow the instructions on the computer screen to reinstall the software. If the install screen does not appear automatically after you restart your computer, do one of the following:

In Windows Vista:

- a Click .
- b Locate the Start Search box.
- c Type **D:\setup.exe**, where **D** is the letter of your CD or DVD drive.

In Windows XP:

- a Click **Start** → **Run**.
- b Type **D:\setup.exe**, where **D** is the letter of your CD or DVD drive.

Using Macintosh

- 1 Close all open software applications.
- 2 From the Finder desktop, double-click the printer folder.
- 3 Double-click the **Uninstaller** icon.
- 4 Follow the instructions on the computer screen to remove the printer software.
- 5 Restart the computer before reinstalling the printer software.
- 6 Insert the installation CD, and then follow the instructions on the computer screen to reinstall the software.

If the software still does not install correctly, visit our Web site at www.lexmark.com to check for the latest software.

- 1 In all countries or regions except the United States, select your country or region.
- 2 Click the links for drivers or downloads.
- 3 Select your printer family.
- 4 Select your printer model.
- 5 Select your operating system.
- 6 Select the file that you want to download, and then follow the directions on the computer screen.

Enabling the USB port in Windows

To confirm that the USB port is enabled on the computer:

- 1 Do one of the following:

In Windows Vista

- a Click  → **Control Panel**.
- b Click **System and Maintenance** → **System**.
- c Click **Device Manager**.

In Windows XP

- a Click **Start**.
- b Click **Control Panel** → **Performance and Maintenance** → **System**.
- c From the Hardware tab, click **Device Manager**.

In Windows 2000

- a Click **Start**.
- b Click **Settings** → **Control Panel** → **System**.
- c From the Hardware tab, click **Device Manager**.

- 2 Click the plus sign (+) beside **Universal Serial Bus Controller**.



If USB Host Controller and USB Root Hub are listed, then the USB port is enabled.

For more information, see the computer documentation.

Solving printer communication problems

The printer and the computer cannot exchange data.

ESTABLISH BIDIRECTIONAL COMMUNICATION BETWEEN THE PRINTER AND THE COMPUTER

- 1 Press  to turn the printer off.
- 2 Disconnect the power cord from the wall outlet.
- 3 Remove the power supply from the printer.
- 4 Reconnect the power supply to the printer.
- 5 Plug the power cord into the wall outlet.
- 6 Press  to turn the printer on.

Notices

Product information

Product name:

Lexmark Z2300 Series

Machine type:

4119

Model(s):

001

Edition notice

January 2008

The following paragraph does not apply to any country where such provisions are inconsistent with local law: LEXMARK INTERNATIONAL, INC., PROVIDES THIS PUBLICATION "AS IS" WITHOUT WARRANTY OF ANY KIND, EITHER EXPRESS OR IMPLIED, INCLUDING, BUT NOT LIMITED TO, THE IMPLIED WARRANTIES OF MERCHANTABILITY OR FITNESS FOR A PARTICULAR PURPOSE. Some states do not allow disclaimer of express or implied warranties in certain transactions; therefore, this statement may not apply to you.

This publication could include technical inaccuracies or typographical errors. Changes are periodically made to the information herein; these changes will be incorporated in later editions. Improvements or changes in the products or the programs described may be made at any time.

References in this publication to products, programs, or services do not imply that the manufacturer intends to make these available in all countries in which it operates. Any reference to a product, program, or service is not intended to state or imply that only that product, program, or service may be used. Any functionally equivalent product, program, or service that does not infringe any existing intellectual property right may be used instead. Evaluation and verification of operation in conjunction with other products, programs, or services, except those expressly designated by the manufacturer, are the user's responsibility.

For Lexmark technical support, visit **support.lexmark.com**.

For information on supplies and downloads, visit **www.lexmark.com**.

If you don't have access to the Internet, you can contact Lexmark by mail:

Lexmark International, Inc.
Bldg 004-2/CSC
740 New Circle Road NW
Lexington, KY 40550
USA

© 2008 Lexmark International, Inc.

All rights reserved.

UNITED STATES GOVERNMENT RIGHTS

This software and any accompanying documentation provided under this agreement are commercial computer software and documentation developed exclusively at private expense.

Trademarks

Lexmark and Lexmark with diamond design are trademarks of Lexmark International, Inc., registered in the United States and/or other countries.

evercolor and PerfectFinish are trademarks of Lexmark International, Inc.

All other trademarks are the property of their respective owners.

Licensing notices

The following document can be viewed from the \Drivers\XPS directory on the installation software CD: Zopen.PDF.

Federal Communications Commission (FCC) compliance information statement

This product has been tested and found to comply with the limits for a Class B digital device, pursuant to Part 15 of the FCC Rules. Operation is subject to the following two conditions: (1) this device may not cause harmful interference, and (2) this device must accept any interference received, including interference that may cause undesired operation.

The FCC Class B limits are designed to provide reasonable protection against harmful interference when the equipment is operated in a residential installation. This equipment generates, uses, and can radiate radio frequency energy and, if not installed and used in accordance with the instructions, may cause harmful interference to radio communications. However, there is no guarantee that interference will not occur in a particular installation. If this equipment does cause harmful interference to radio or television reception, which can be determined by turning the equipment off and on, the user is encouraged to try to correct the interference by one or more of the following measures:

- Reorient or relocate the receiving antenna.
- Increase the separation between the equipment and receiver.
- Connect the equipment into an outlet on a circuit different from that to which the receiver is connected.
- Consult your point of purchase or service representative for additional suggestions.

The manufacturer is not responsible for radio or television interference caused by using other than recommended cables or by unauthorized changes or modifications to this equipment. Unauthorized changes or modifications could void the user's authority to operate this equipment.

Note: To assure compliance with FCC regulations on electromagnetic interference for a Class B computing device, use a properly shielded and grounded cable such as Lexmark part number 1021294 for USB attach. Use of a substitute cable not properly shielded and grounded may result in a violation of FCC regulations.

Any questions regarding this compliance information statement should be directed to:

Director of Lexmark Technology & Services
Lexmark International, Inc.
740 West New Circle Road
Lexington, KY 40550
(859) 232-3000

Exposure to radio frequency radiation

The following notice is applicable if your printer has a wireless network card installed.

The radiated output power of this device is far below the radio frequency exposure limits of the FCC and other regulatory agencies. A minimum separation of 20 cm (8 inches) must be maintained between the antenna and any persons for this device to satisfy the RF exposure requirements of the FCC and other regulatory agencies.

Industry Canada compliance statement

This Class B digital apparatus meets all requirements of the Canadian Interference-Causing Equipment Standard ICES-003.

Avis de conformité aux normes de l'industrie du Canada

Cet appareil numérique de classe B est conforme aux exigences de la norme canadienne relative aux équipements pouvant causer des interférences NMB-003.

Industry Canada notice

The following notices are applicable if your printer has a wireless network card installed.

Industry Canada (Canada)

This device complies with Industry Canada specification RSS-210. Operation is subject to the following two conditions: (1) this device may not cause interference, and (2) this device must accept any interference, including interference that may cause undesired operation of the device.

This device has been designed to operate only with the antenna provided. Use of any other antenna is strictly prohibited per regulations of Industry Canada.

To prevent radio interference to the licensed service, this device is intended to be operated indoors and away from windows to provide maximum shielding. Equipment (or its transmit antenna) that is installed outdoors is subject to licensing.

The installer of this radio equipment must ensure that the antenna is located or pointed such that it does not emit RF fields in excess of Health Canada limits for the general population; consult Safety Code 6, obtainable from Health Canada's Web site www.hc-sc.gc.ca/rpb.

The term "IC:" before the certification/registration number only signifies that the Industry Canada technical specifications were met.

Industry Canada (Canada)

Cet appareil est conforme à la norme RSS-210 d'Industry Canada. Son fonctionnement est soumis aux deux conditions suivantes :

(1) cet appareil ne doit pas provoquer d'interférences et (2) il doit accepter toute interférence reçue, y compris celles risquant d'altérer son fonctionnement.

Cet appareil a été conçu pour fonctionner uniquement avec l'antenne fournie. L'utilisation de toute autre antenne est strictement interdite par la réglementation d'Industry Canada.

En application des réglementations d'Industry Canada, l'utilisation d'une antenne de gain supérieur est strictement interdite.

Pour empêcher toute interférence radio au service faisant l'objet d'une licence, cet appareil doit être utilisé à l'intérieur et loin des fenêtres afin de garantir une protection optimale.

Si le matériel (ou son antenne d'émission) est installé à l'extérieur, il doit faire l'objet d'une licence.

L'installateur de cet équipement radio doit veiller à ce que l'antenne soit implantée et dirigée de manière à n'émettre aucun champ HF dépassant les limites fixées pour l'ensemble de la population par Santé Canada. Reportez-vous au Code de sécurité 6 que vous pouvez consulter sur le site Web de Santé Canada www.hc-sc.gc.ca/rpb.

Le terme « IC » précédant le numéro de d'accréditation/inscription signifie simplement que le produit est conforme aux spécifications techniques d'Industry Canada.

European Community (EC) directives conformity

This product is in conformity with the protection requirements of EC Council directives 2004/108/EC and 2006/95/EC on the approximation and harmonization of the laws of the Member States relating to electromagnetic compatibility and safety of electrical equipment designed for use within certain voltage limits.

A declaration of conformity with the requirements of the directives has been signed by the Director of Manufacturing and Technical Support, Lexmark International, Inc., S.A., Boigny, France.

This product satisfies the Class B limits of EN 55022 and safety requirements of EN 60950.

European EC directives conformity statement for radio products

The following notices are applicable if your printer has a wireless network card installed

This product is in conformity with the protection requirements of EC Council directives 2004/108/EC, 2006/95/EC, and 1999/5/EC on the approximation and harmonization of the laws of the Member States relating to electromagnetic compatibility, safety of electrical equipment designed for use within certain voltage limits and on radio equipment and telecommunications terminal equipment.

Compliance is indicated by the CE marking.



The Alert sign indicates that there are restrictions within certain member states.

A declaration of conformity with the requirements of the directives is available from the Director of Manufacturing and Technical Support, Lexmark International, S. A., Boigny, France.

The following restrictions apply:

Country/region	Restriction
All countries/regions	This product is for indoor use only. This product may not be used outdoors.
L'Italia	Si fa presente inoltre che l'uso degli apparati in esame è regolamentato da: <ul style="list-style-type: none">• D.Lgs 1.8.2003, n.259, articoli 104 (attività soggette ad autorizzazione generale) e 105 (libero uso), per uso privato;• D.M. 28.5.03, per la fornitura al pubblico dell'accesso R-LAN alle reti e ai servizi di telecomunicazioni.

This product satisfies the limits of EN 55022; safety requirements of EN 60950; radio spectrum requirements of ETSI EN 300 328; and the EMC requirements of EN 55024, ETSI EN 301 489-1 and ETSI EN 301 489-17.

Česky	Společnost Lexmark International, Inc. tímto prohlašuje, že výrobek tento výrobek je ve shodě se základními požadavky a dalšími příslušnými ustanoveními směrnice 1999/5/ES.
Dansk	Lexmark International, Inc. erklærer herved, at dette produkt overholder de væsentlige krav og øvrige relevante krav i direktiv 1999/5/EF.
Deutsch	Hiermit erklärt Lexmark International, Inc., dass sich das Gerät dieses Gerät in Übereinstimmung mit den grundlegenden Anforderungen und den übrigen einschlägigen Bestimmungen der Richtlinie 1999/5/EG befindet.
Ελληνική	ΜΕ ΤΗΝ ΠΑΡΟΥΣΑ Η LEXMARK INTERNATIONAL, INC. ΔΗΛΩΝΕΙ ΟΤΙ ΑΥΤΟ ΤΟ ΠΡΟΪΟΝ ΣΥΜΜΟΡΦΩΝΕΤΑΙ ΠΡΟΣ ΤΙΣ ΟΥΣΙΩΔΕΙΣ ΑΠΑΙΤΗΣΕΙΣ ΚΑΙ ΤΙΣ ΛΟΙΠΕΣ ΣΧΕΤΙΚΕΣ ΔΙΑΤΑΞΕΙΣ ΤΗΣ ΟΔΗΓΙΑΣ 1999/5/ΕΚ.
English	Hereby, Lexmark International, Inc., declares that this type of equipment is in compliance with the essential requirements and other relevant provisions of Directive 1999/5/EC.
Español	Por medio de la presente, Lexmark International, Inc. declara que este producto cumple con los requisitos esenciales y cualesquiera otras disposiciones aplicables o exigibles de la Directiva 1999/5/CE.
Eesti	Käesolevaga kinnitab Lexmark International, Inc., et seade see toode vastab direktiivi 1999/5/EÜ põhinõuetele ja nimetatud direktiivist tulenevatele muudele asjakohastele sätetele.
Suomi	Lexmark International, Inc. vakuuttaa täten, että tämä tuote on direktiivin 1999/5/EY oleellisten vaatimusten ja muiden sitä koskevien direktiivin ehtojen mukainen.
Français	Par la présente, Lexmark International, Inc. déclare que l'appareil ce produit est conforme aux exigences fondamentales et autres dispositions pertinentes de la directive 1999/5/CE.
Magyar	Alulírott, Lexmark International, Inc. nyilatkozom, hogy a termék megfelel a vonatkozó alapvető követelményeknek és az 1999/5/EC irányelv egyéb előírásainak.
Íslenska	Hér með lýsir Lexmark International, Inc. yfir því að þessi vara er í samræmi við grunnkröfur og aðrar kröfur, sem gerðar eru í tilskipun 1999/5/EC.
Italiano	Con la presente Lexmark International, Inc. dichiara che questo prodotto è conforme ai requisiti essenziali ed alle altre disposizioni pertinenti stabilite dalla direttiva 1999/5/CE.
Latviski	Ar šo Lexmark International, Inc. deklarē, ka šis izstrādājums atbilst Direktīvas 1999/5/EK būtiskajām prasībām un citiem ar to saistītajiem noteikumiem.
Lietuvių	Šiuo Lexmark International, Inc. deklaruoja, kad šis produktas atitinka esminius reikalavimus ir kitas 1999/5/EB direktyvos nuostatas.
Malti	Bil-preżenti, Lexmark International, Inc., jiddikjara li dan il-prodott huwa konformi mal-ftiġġijiet essenzjali u ma dispożizzjonijiet oħrajn relevanti li jinsabu fid-Direttiva 1999/5/KE.
Nederlands	Hierbij verklaart Lexmark International, Inc. dat het toestel dit product in overeenstemming is met de essentiële eisen en de andere relevante bepalingen van richtlijn 1999/5/EG.
Norsk	Lexmark International, Inc. erklærer herved at dette produktet er i samsvar med de grunnleggende krav og øvrige relevante krav i direktiv 1999/5/EF.
Polski	Niniejszym Lexmark International, Inc. oświadcza, że niniejszy produkt jest zgodny z zasadniczymi wymogami oraz pozostałymi stosownymi postanowieniami Dyrektywy 1999/5/EC.

Português	A Lexmark International Inc. declara que este produto está conforme com os requisitos essenciais e outras disposições da Diretiva 1999/5/CE.
Slovensky	Lexmark International, Inc. týmto vyhlasuje, že tento produkt spĺňa základné požiadavky a všetky príslušné ustanovenia smernice 1999/5/ES.
Slovensko	Lexmark International, Inc. izjavlja, da je ta izdelek v skladu z bistvenimi zahtevami in ostalimi relevantnimi določili direktive 1999/5/ES.
Svenska	Härmed intygar Lexmark International, Inc. att denna produkt står i överensstämmelse med de väsentliga egenskapskrav och övriga relevanta bestämmelser som framgår av direktiv 1999/5/EG.

Noise emission levels

The following measurements were made in accordance with ISO 7779 and reported in conformance with ISO 9296.

Note: Some modes may not apply to your product.

1-meter average sound pressure, dBA	
Printing	53
Ready	inaudible

Values are subject to change. See www.lexmark.com for current values.

Waste from Electrical and Electronic Equipment (WEEE) directive



The WEEE logo signifies specific recycling programs and procedures for electronic products in countries of the European Union. We encourage the recycling of our products. If you have further questions about recycling options, visit the Lexmark Web site at www.lexmark.com for your local sales office phone number.

Product disposal

Do not dispose of the printer or supplies in the same manner as normal household waste. Consult your local authorities for disposal and recycling options.

Temperature information

Ambient temperature	15–32° C (60–90° F)
Shipping temperature	-40–60° C (-40–140° F)
Storage temperature	1–60° C (34–140° F)

Power consumption

Product power consumption

The following table documents the power consumption characteristics of the product.

Note: Some modes may not apply to your product.

Mode	Description	Power consumption (Watts)
Printing	The product is generating hard-copy output from electronic inputs.	13
Copying	The product is generating hard-copy output from hard-copy original documents.	not applicable
Scanning	The product is scanning hard-copy documents.	not applicable
Ready	The product is waiting for a print job.	2
Power Saver	The product is in energy-saving mode.	not applicable
Off	The product is plugged into a wall outlet, but the power switch is turned off.	2

The power consumption levels listed in the previous table represent time-averaged measurements. Instantaneous power draws may be substantially higher than the average.

Values are subject to change. See www.lexmark.com for current values.

Power Saver

This product is designed with an energy-saving mode called Power Saver. The Power Saver Mode is equivalent to the EPA Sleep Mode. The Power Saver Mode saves energy by lowering power consumption during extended periods of inactivity. The Power Saver Mode is automatically engaged after this product is not used for a specified period of time, called the Power Saver Timeout.

Factory default Power Saver Timeout for this product (in minutes):	not applicable
--	----------------

Off mode

If this product has an off mode which still consumes a small amount of power, then to completely stop product power consumption, disconnect the power supply cord from the wall outlet.

Total energy usage

It is sometimes helpful to calculate the total product energy usage. Since power consumption claims are provided in power units of Watts, the power consumption should be multiplied by the time the product spends in each mode in order to calculate energy usage. The total product energy usage is the sum of each mode's energy usage.

LEXMARK LICENSE AGREEMENTS

PLEASE READ CAREFULLY: BY USING THIS PRODUCT, YOU AGREE TO BE BOUND BY ALL THE TERMS AND CONDITIONS OF THESE LICENSE AGREEMENTS. IF YOU DO NOT AGREE WITH THE TERMS OF THESE LICENSE AGREEMENTS, PROMPTLY RETURN THE PRODUCT UNUSED AND REQUEST A REFUND OF THE AMOUNT YOU PAID. IF YOU ARE INSTALLING THIS PRODUCT FOR USE BY OTHER PARTIES, YOU AGREE TO INFORM THE USERS THAT USE OF THE PRODUCT INDICATES ACCEPTANCE OF THESE TERMS.

CARTRIDGE LICENSE AGREEMENT

I agree that the patented print cartridge(s) shipped with this printing device are sold subject to the following license/agreement: The patented print cartridge(s) contained inside is/are licensed for a single use only and is/are designed to stop working after delivering a fixed amount of ink. A variable amount of ink will remain in the cartridge when replacement is required. After this single use, the license to use the print cartridge terminates, and the used cartridge must be returned only to Lexmark for remanufacturing, refilling or recycling. If I buy another cartridge in the future that is sold subject to the above terms, I accept such terms as to that cartridge. If you do not accept the terms of this single use license/agreement; return this product in its original packaging to your point of purchase. A replacement cartridge sold without these terms is available at www.lexmark.com.

LEXMARK SOFTWARE LICENSE AGREEMENT

This Software License Agreement ("License Agreement") is a legal agreement between you (either an individual or a single entity) and Lexmark International, Inc. ("Lexmark") that, to the extent your Lexmark product or Software Program is not otherwise subject to a written software license agreement between you and Lexmark or its suppliers, governs your use of any Software Program installed on or provided by Lexmark for use in connection with your Lexmark product. The term "Software Program" includes machine-readable instructions, audio/visual content (such as images and recordings), and associated media, printed materials and electronic documentation, whether incorporated into, distributed with or for use with your Lexmark product.

- 1 STATEMENT OF LIMITED WARRANTY.** Lexmark warrants that the media (e.g., diskette or compact disk) on which the Software Program (if any) is furnished is free from defects in materials and workmanship under normal use during the warranty period. The warranty period is ninety (90) days and commences on the date the Software Program is delivered to the original end-user. This limited warranty applies only to Software Program media purchased new from Lexmark or an Authorized Lexmark Reseller or Distributor. Lexmark will replace the Software Program should it be determined that the media does not conform to this limited warranty.
- 2 DISCLAIMER AND LIMITATION OF WARRANTIES.** EXCEPT AS PROVIDED IN THIS LICENSE AGREEMENT AND TO THE MAXIMUM EXTENT PERMITTED BY APPLICABLE LAW, LEXMARK AND ITS SUPPLIERS PROVIDE THE SOFTWARE PROGRAM "AS IS" AND HEREBY DISCLAIM ALL OTHER WARRANTIES AND CONDITIONS, EITHER EXPRESS OR IMPLIED, INCLUDING, BUT NOT LIMITED TO, TITLE, NON-INFRINGEMENT, MERCHANTABILITY AND FITNESS FOR A PARTICULAR PURPOSE, AND ABSENCE OF VIRUSES, ALL WITH REGARD TO THE SOFTWARE PROGRAM. This Agreement is to be read in conjunction with certain statutory provisions, as that may be in force from time to time, that imply warranties or conditions or impose obligations on Lexmark that cannot be excluded or modified. If any such provisions apply, then to the extent Lexmark is able, Lexmark hereby limits its liability for breach of those provisions to one of the following: replacement of the Software Program or reimbursement of the price paid for the Software Program.

- 3 LICENSE GRANT.** Lexmark grants you the following rights provided you comply with all terms and conditions of this License Agreement:
- a Use.** You may Use one (1) copy of the Software Program. The term “Use” means storing, loading, installing, executing, or displaying the Software Program. If Lexmark has licensed the Software Program to you for concurrent use, you must limit the number of authorized users to the number specified in your agreement with Lexmark. You may not separate the components of the Software Program for use on more than one computer. You agree that you will not Use the Software Program, in whole or in part, in any manner that has the effect of overriding, modifying, eliminating, obscuring, altering or de-emphasizing the visual appearance of any trademark, trade name, trade dress or intellectual property notice that appears on any computer display screens normally generated by, or as a result of, the Software Program.
 - b Copying.** You may make one (1) copy of the Software Program solely for purposes of backup, archiving, or installation, provided the copy contains all of the original Software Program’s proprietary notices. You may not copy the Software Program to any public or distributed network.
 - c Reservation of Rights.** The Software Program, including all fonts, is copyrighted and owned by Lexmark International, Inc. and/or its suppliers. Lexmark reserves all rights not expressly granted to you in this License Agreement.
 - d Freeware.** Notwithstanding the terms and conditions of this License Agreement, all or any portion of the Software Program that constitutes software provided under public license by third parties (“Freeware”) is licensed to you subject to the terms and conditions of the software license agreement accompanying such Freeware, whether in the form of a discrete agreement, shrink-wrap license, or electronic license terms at the time of download. Use of the Freeware by you shall be governed entirely by the terms and conditions of such license.
- 4 TRANSFER.** You may transfer the Software Program to another end-user. Any transfer must include all software components, media, printed materials, and this License Agreement and you may not retain copies of the Software Program or components thereof. The transfer may not be an indirect transfer, such as a consignment. Prior to the transfer, the end-user receiving the transferred Software Program must agree to all these License Agreement terms. Upon transfer of the Software Program, your license is automatically terminated. You may not rent, sublicense, or assign the Software Program except to the extent provided in this License Agreement, and any attempt to do so shall be void.
- 5 UPGRADES.** To Use a Software Program identified as an upgrade, you must first be licensed to the original Software Program identified by Lexmark as eligible for the upgrade. After upgrading, you may no longer use the original Software Program that formed the basis for your upgrade eligibility.
- 6 LIMITATION ON REVERSE ENGINEERING.** You may not alter, decrypt, reverse engineer, reverse assemble, reverse compile or otherwise translate the Software Program, except as and to the extent expressly permitted to do so by applicable law for the purposes of inter-operability, error correction, and security testing. If you have such statutory rights, you will notify Lexmark in writing of any intended reverse engineering, reverse assembly, or reverse compilation. You may not decrypt the Software Program unless necessary for the legitimate Use of the Software Program.
- 7 ADDITIONAL SOFTWARE.** This License Agreement applies to updates or supplements to the original Software Program provided by Lexmark unless Lexmark provides other terms along with the update or supplement.
- 8 LIMITATION OF REMEDIES.** To the maximum extent permitted by applicable law, the entire liability of Lexmark, its suppliers, affiliates, and resellers, and your exclusive remedy shall be as follows: Lexmark will provide the express limited warranty described above. If Lexmark does not remedy defective media as warranted, you may terminate your license and your money will be refunded upon the return of all of your copies of the Software Program.

9 LIMITATION OF LIABILITY. To the maximum extent permitted by applicable law, for any claim arising out of Lexmark's limited warranty, or for any other claim whatsoever related to the subject matter of this Agreement, Lexmark's and its suppliers' liability for all types of damages, regardless of the form of action or basis (including contract, breach, estoppel, negligence, misrepresentation, or tort), shall be limited to the greater of \$5,000 or the money paid to Lexmark or its Authorized remarketers for the license hereunder for the Software Program that caused the damages or that is the subject matter of, or is directly related to, the cause of action.

IN NO EVENT WILL LEXMARK, ITS SUPPLIERS, SUBSIDIARIES, OR RESELLERS BE LIABLE FOR ANY SPECIAL, INCIDENTAL, INDIRECT, EXEMPLARY, PUNITIVE, OR CONSEQUENTIAL DAMAGES (INCLUDING BUT NOT LIMITED TO LOST PROFITS OR REVENUES, LOST SAVINGS, INTERRUPTION OF USE OR ANY LOSS OF, INACCURACY IN, OR DAMAGE TO, DATA OR RECORDS, FOR CLAIMS OF THIRD PARTIES, OR DAMAGE TO REAL OR TANGIBLE PROPERTY, FOR LOSS OF PRIVACY ARISING OUT OR IN ANY WAY RELATED TO THE USE OF OR INABILITY TO USE THE SOFTWARE PROGRAM, OR OTHERWISE IN CONNECTION WITH ANY PROVISION OF THIS LICENSE AGREEMENT), REGARDLESS OF THE NATURE OF THE CLAIM, INCLUDING BUT NOT LIMITED TO BREACH OF WARRANTY OR CONTRACT, TORT (INCLUDING NEGLIGENCE OR STRICT LIABILITY), AND EVEN IF LEXMARK, OR ITS SUPPLIERS, AFFILIATES, OR REMARKETERS HAVE BEEN ADVISED OF THE POSSIBILITY OF SUCH DAMAGES, OR FOR ANY CLAIM BY YOU BASED ON A THIRD-PARTY CLAIM, EXCEPT TO THE EXTENT THIS EXCLUSION OF DAMAGES IS DETERMINED LEGALLY INVALID. THE FOREGOING LIMITATIONS APPLY EVEN IF THE ABOVE-STATED REMEDIES FAIL OF THEIR ESSENTIAL PURPOSE.

- 10 TERM.** This License Agreement is effective unless terminated or rejected. You may reject or terminate this license at any time by destroying all copies of the Software Program, together with all modifications, documentation, and merged portions in any form, or as otherwise described herein. Lexmark may terminate your license upon notice if you fail to comply with any of the terms of this License Agreement. Upon such termination, you agree to destroy all copies of the Software Program together with all modifications, documentation, and merged portions in any form.
- 11 TAXES.** You agree that you are responsible for payment of any taxes including, without limitation, any goods and services and personal property taxes, resulting from this Agreement or your Use of the Software Program.
- 12 LIMITATION ON ACTIONS.** No action, regardless of form, arising out of this Agreement may be brought by either party more than two years after the cause of action has arisen, except as provided under applicable law.
- 13 APPLICABLE LAW.** This Agreement is governed by the laws of the Commonwealth of Kentucky, United States of America. No choice of law rules in any jurisdiction shall apply. The UN Convention on Contracts for the International Sale of Goods shall not apply.
- 14 UNITED STATES GOVERNMENT RESTRICTED RIGHTS.** The Software Program has been developed entirely at private expense. Rights of the United States Government to use the Software Program is as set forth in this Agreement and as restricted in DFARS 252.227-7014 and in similar FAR provisions (or any equivalent agency regulation or contract clause).
- 15 CONSENT TO USE OF DATA.** You agree that Lexmark, its affiliates, and agents may collect and use information you provide in relation to support services performed with respect to the Software Program and requested by you. Lexmark agrees not to use this information in a form that personally identifies you except to the extent necessary to provide such services.
- 16 EXPORT RESTRICTIONS.** You may not (a) acquire, ship, transfer, or reexport, directly or indirectly, the Software Program or any direct product therefrom, in violation of any applicable export laws or (b) permit the Software Program to be used for any purpose prohibited by such export laws, including, without limitation, nuclear, chemical, or biological weapons proliferation.
- 17 AGREEMENT TO CONTRACT ELECTRONICALLY.** You and Lexmark agree to form this License Agreement electronically. This means that when you click the "Agree" or "Yes" button on this page or use this product, you acknowledge your agreement to these License Agreement terms and conditions and that you are doing so with the intent to "sign" a contract with Lexmark.

18 CAPACITY AND AUTHORITY TO CONTRACT. You represent that you are of the legal age of majority in the place you sign this License Agreement and, if applicable, you are duly authorized by your employer or principal to enter into this contract.

19 ENTIRE AGREEMENT. This License Agreement (including any addendum or amendment to this License Agreement that is included with the Software Program) is the entire agreement between you and Lexmark relating to the Software Program. Except as otherwise provided for herein, these terms and conditions supersede all prior or contemporaneous oral or written communications, proposals, and representations with respect to the Software Program or any other subject matter covered by this License Agreement (except to the extent such extraneous terms do not conflict with the terms of this License Agreement, any other written agreement signed by you and Lexmark relating to your Use of the Software Program). To the extent any Lexmark policies or programs for support services conflict with the terms of this License Agreement, the terms of this License Agreement shall control.

Index

A

access cover 8
aligning print cartridges 30

C

canceling
 print jobs 19
cards, loading 14
cartridge, print
 removing 29
cartridges, print
 aligning 30
 cleaning 31
 installing 28
 ordering 33
 preserving 32
 using genuine Lexmark 30
 wiping 31

CD

printing photos from 26
cleaning
 exterior of the printer 33
cleaning print cartridge nozzles 31
custom-size paper, loading 15, 23
custom-size paper, printing 23

D

document
 multiple copies, printing 17
documents
 printing 16

E

emission notices 43, 44, 45, 46, 47
envelopes
 loading 21
 printing 21
envelopes, loading 14
exterior of the printer
 cleaning 33

F

FCC notices 43, 44
finding
 information 6
 publications 6
 Web site 6

G

glossy and photo paper,
loading 13, 16

I

information, finding 6
installing
 print cartridges 28
 printer software 9, 39
iron-on transfers, loading 14

L

labels, loading 14
labels, printing 22
last page first, printing 18
loading
 cards 14
 custom-size paper 15, 23
 envelopes 14, 21
 glossy and photo paper 13, 16
 iron-on transfers 14
 labels 14
 paper 13, 16
 plain paper 13
 transparencies 15

M

Mac printer software
 using 12
multiple copies, printing 17

N

noise emission levels 47
notices 43, 44, 45, 46, 47, 48
N-up feature 18

O

ordering paper and other
supplies 34

P

page does not print 37
paper
 choosing specialty 21
 paper and other supplies
 ordering 34

paper exit tray 8
paper guide 8
paper support 8
paper, loading 13, 16
parts
 access cover 8
 paper exit tray 8
 paper guide 8
 paper support 8
 power button 8
 power supply 9
 USB port 9
photos
 printing from CD using the
 computer 26
 printing from digital camera
 connected to computer 26
 printing from removable storage
 device connected to
 computer 26
plain paper, loading 13
power button 8
power button is not lit 35
power supply 9
print cartridge
 removing 29
print cartridge nozzles,
cleaning 31
print cartridges
 aligning 30
 cleaning 31
 installing 28
 ordering 33
 preserving 32
 refilling 30
 using genuine Lexmark 30
 wiping 31
print jobs, canceling 19
print settings
 saving and deleting 24
printer software
 installing 9
 reinstalling 39
 removing 39
printing
 collate 17
 custom-size paper 23
 documents 16

- envelopes 21
- labels 22
- last page first 18
- multiple copies 17
- multiple pages on one sheet 18
- photos from CD using the computer 26
- photos from digital camera connected to computer 26
- photos from removable storage device connected to computer 26
- reverse page order 18
- specialty documents 24
- Web page 16
- printing photos
 - from digital camera connected to computer 26
 - from flash drive connected to computer 26
 - from memory card connected to computer 26
- publications, finding 6

R

- recycling
 - WEEE statement 47
- refilling print cartridges 30
- removing print cartridge 29
- reverse page order 18

S

- safety information 5
- saving and deleting print settings 24
- security information 8
- Service Center 35
- setup troubleshooting
 - page does not print 37
 - power button is not lit 35
 - software did not install 36
- software
 - removing and reinstalling 39
 - Service Center 35
 - XPS driver 10
- software did not install 36
- solving printer communication problems 41
- specialty documents, printing 24

T

- Toolbar
 - printing a Web page 16
- transparencies, loading 15
- troubleshooting
 - printer communication problems 41
 - Service Center 35
- troubleshooting, setup
 - page does not print 37
 - power button is not lit 35
 - software did not install 36

U

- USB port 9
 - enabling 40
- using
 - Mac printer software 12

W

- Web page
 - printing 16
- Web site
 - finding 6
- Windows software
 - FastPics 11
 - Fax Setup Utility 11
 - Fax Solutions Software 11
 - Printing Preferences 11
 - Productivity Studio 11
 - Wireless Setup Utility 11

X

- XPS driver
 - installing 10